

ALLIANCE

Specification Sheet

Model: ALSTEM24 (24" Area Light Stem)

Fixture Height: 24.5" - 25.5", (62.2-64.8 cm)
 Stem Diameter: 1.6" (4.1 cm)

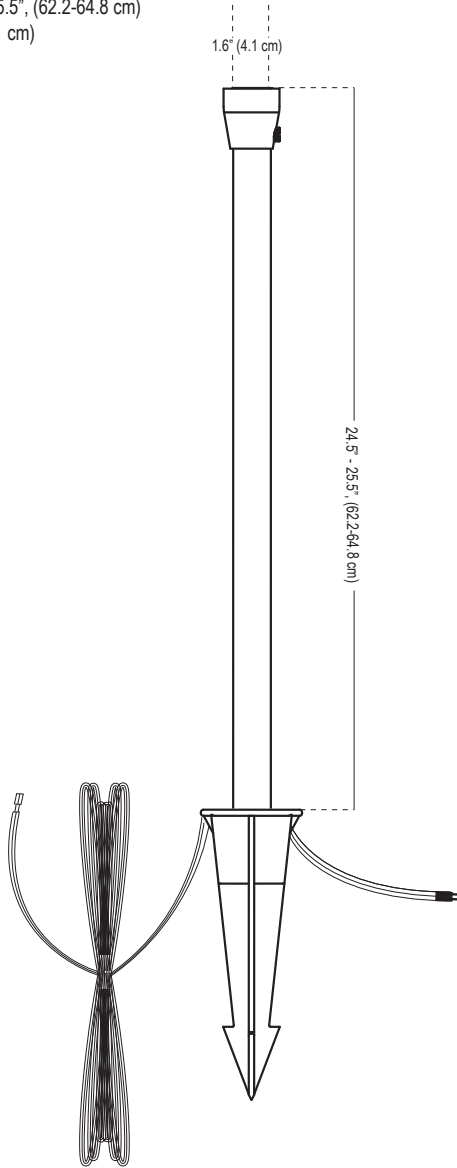

Notes:

Project:
Type:

Specifications and Features:

- Body:** Brass stem, aged brass finish
- Collar:** Brass, adjustable with thumb screw
- Socket:** Spring loaded ceramic bi-pin socket with dual contact
- Wire:** Industry First, double wire lead pre-connected to the fixture, 16 awg (*UL listed*), brown
 - 25 foot wire lead, pre-stripped for easy wire connection
 - 18 inch wire lead, LED connection ready
- Stake:** Plastic ground stake, attached to the fixture (8.5 in; 21.6 cm length)
- Warranty:** Lifetime warranty on fixture housing
- Certification:** Complies with the requirements of UL-1838 and CAN/CSA-C22.2 No. 250.7. Identified with the ETL and cETL Listed Mark.



Lamp Options

Model #	Base Type	Wattage	Lumen Output
LBIPIN-LED-3W	BIPIN/G4	3w	150lm
LXELOGEN-20 (Halogen)	BIPIN/G4	20w	150lm

LED Ordering Guide: Model-LED

Example: ALSTEM24-LED

Accessories Available:

Mounting Accessories:
RMB - Round Mounting Base

Project:
Type:

Model: LBIPIN-LED-3W (3 watt BIPIN LED)

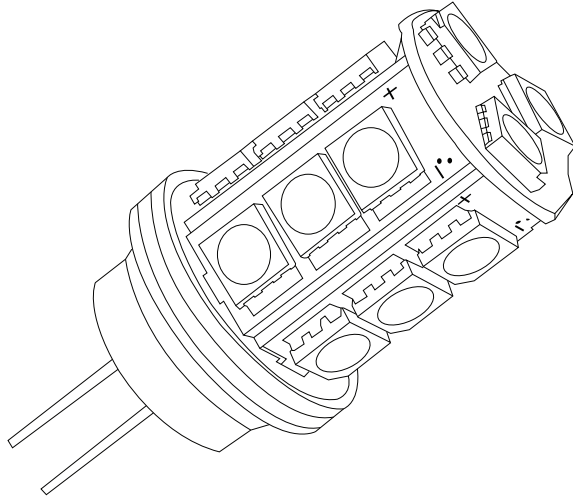

Specifications and Features:

- Watts:** 3
- Base Type:** G4/BiPin
- Light Output:** 150 lumens
- Color:** Warm White
- Color Temperatures:** 2700K
- Operating Voltage:** 8-24v
- CRI:** Ra>80
- LED Chip Qty:** 18 Pieces
- Halogen Equivalent:** 20w
- Rated Hours:** 50,000 hrs
- Ambient Operating Temperature:** <72°C
- Transformer Compatibility:** Must be powered by magnetic transformer
- Warranty:** Five year limited warranty on LED components

Lamp Color Options

Model #	Color	Color Temp.	Base Type	Wattage	Lumen Output
LBIPINLED-3W-3K	Bright White	3000K	BIPIN/G4	3w	150lm
LBIPIN-LED-3W-AMBER*	Amber	Amber	BIPIN/G4	3w	150lm

*Turtle Safe

Notes: