

Project:
Type:

Model: LMR16-LED-4W-NS (MR16 LED)

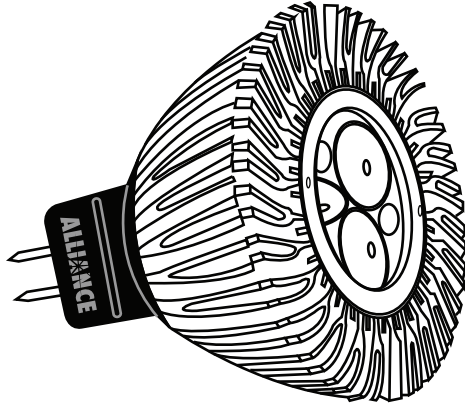

Specifications and Features:

- Base:** MR16
- Watts:** 4
- Beam Angle:** 15°
- Beam Spread:** Narrow Spot
- Light Output:** 250 lumens
- Color:** Warm White
- Color Temperature:** 2900K
- Operating Voltage:** 12-24v
- CRI:** Ra>80
- LED Source:** CREE XPE
- Halogen Equivalent:** 35w
- Rated Hours:** 50,000 hrs
- Ambient Operating Temperature:** <72°C

Photometrics:

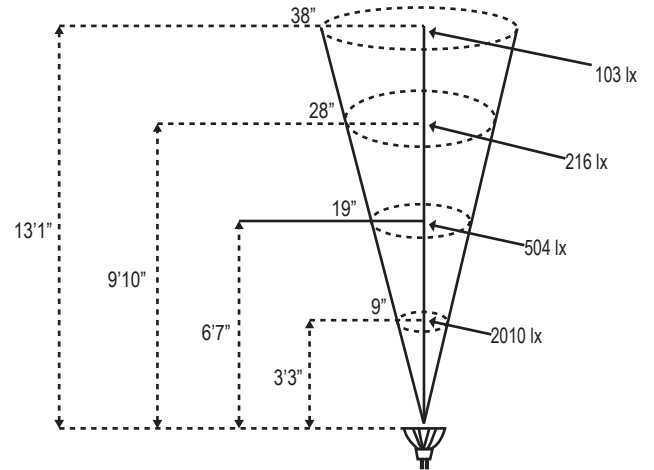

Notes: